



Osnovan 1.02.1992.

# INGAL

Izrada okova za aluminijumsku bravariju



11 000 Beograd, Srbija



Avgusta Cesarca 8a

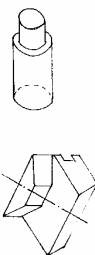
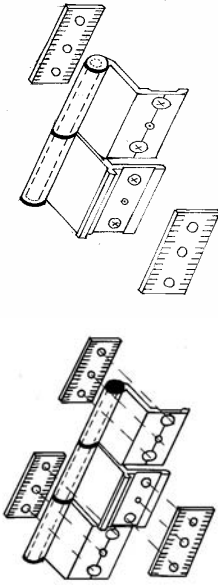
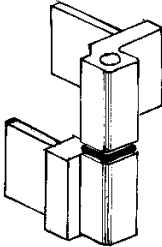

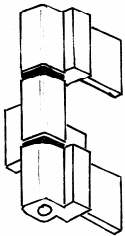
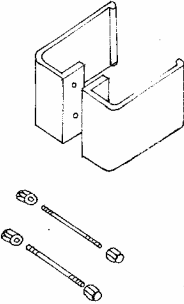
☎ 011/36 70 569

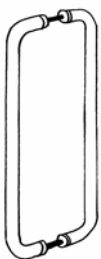
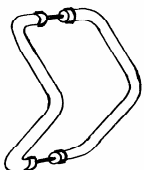
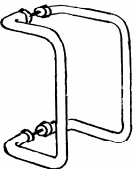

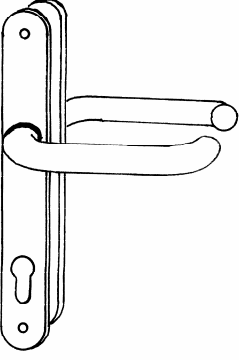
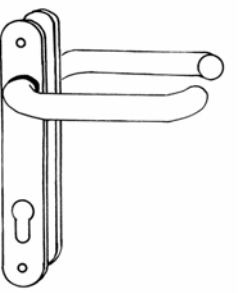
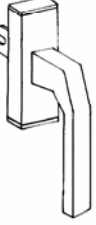
Mob ☎ 063/223 754

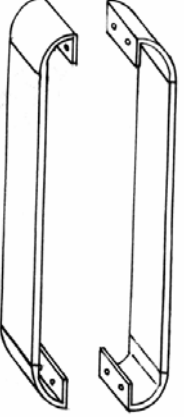
Proizvod	Artikal/Naziv	Upotreba	Napomena	Cena EURO Netto izlazna
	<b>IN 001.10</b> <b>IN 001.7</b> <b>IN 001.4</b>  Šlic Pleh	D = 10mm D = 7mm D = 4mm	✓ Plastificiran ✓ Eloxiran	☞ 1,50
	<b>IN 002</b> <b>IN 003</b> Tuljak Prihvatnik	-Ugradnja u al.sisteme sa evro žljebom		☞ 0,25 ☞ 0,75
	<b>IN 004</b> Šarka za prozor  <b>IN 004/3</b> Šarka za balkonska, jednokrilna i dvokrilna vrata	-Ugradnja u al.sisteme sa evro žljebom	✓ Plastificirana ✓ Eloxirana  -Plastificirana -Eloxirana	☞ 2,75 ☞ 3,25  3,75 4,25
	<b>IN 005</b> Šarka za vrata	Ugradnja prema tehničkom uputstvu -Ingal45, T55 -Nisal, Yugal -Tehnomarket	✓ Plastificirana ✓ Eloxirana	☞ 5,75 ☞ 6,50

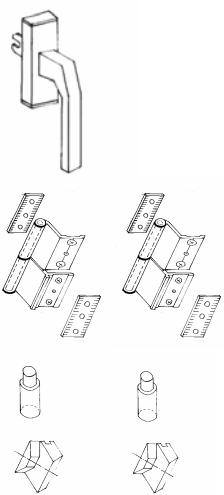
	<b>IN 006</b> Šarka za vrata “Trodelna”	-Za vrata krilo na krilo	✓ Plastificirana ✓ Eloxirana	⇨ 8,0 ⇨ 9,0
	<b>IN 007</b> Rukohvat “Slonovo uvo” 1.H = 150 mm 2.H = 250 mm*	-Za jednokrilna i dvokrilna vrata Isporučuje se sa brezonima I slepim maticama	Sirovo ✓ Plastificiran ✓ Eloxiran  Plastificiran Eloxiran	12,0 H=150mm ⇨ 13,0 ⇨ 14,0 H=200 mm 17,00  Sirovo 17.60 H =250mm 19,60 21,00
	<b>IN 008</b> Cevni rukohvat “Slomljeni P”	-Za jednokrilna i dvokrilna vrata	L<1m; ✓ Plastificirano ✓ Eloxirano	⇨ 36,50 ⇨ 38.50
	<b>IN 009</b> Cevni rukohvat “P”	-Za jednokrilna i dvokrilna vrata	L<1m; ✓ Plastificirano ✓ Eloxirano  L=0,3m; ✓ Plastificirano ✓ Eloxirano	⇨ 31,0 ⇨ 36,0  ⇨ 23,50 ⇨ 28,50
	<b>IN 010</b> Cevni rukohvat “V” H = 300 mm H= 250 mm*	-Za jednokrilna i dvokrilna vrata	✓ Plastificiran ✓ Eloxiran	⇨ 25,0 ⇨ 30,0
	<b>IN 011</b> Cevni rukohvat “Slonovo uvo” H = 300 mm H = 250 mm*	-Za jednokrilna i dvokrilna vrata	✓ Plastificiran ✓ Eloxiran	⇨ 30,0 ⇨ 35,0

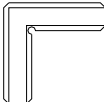
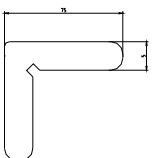
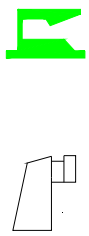
	<p><b>IN 012</b> Kvaka sa šildovima za drvena vrata sa zavrtnjima</p>	<p>-Četvrtka 8x8 ili 9x9</p> <p>-Rastojanje od kvake do cilindra prema bravi</p>	<p>✓ Plastificirana ✓ Eloxirana</p>	<p>☞ 8,25 ☞ 10,25</p>
	<p><b>IN 013</b> Kvaka sa šildovima za al.vrata sa zavrtnjima</p>	<p>-Četvrtka 8x8 ili 9x9</p> <p>-Rastojanje od kvake do cilindra prema bravi</p>	<p>✓ Plastificirana ✓ Eloxirana</p>	<p>☞ 8,0 ☞ 10,0</p>
	<p><b>IN 014</b> Ručica za prozor</p> <p><b>NEMA !!!</b></p>	<p>-Ugradnja u al.sisteme sa evro žljebom</p>	<p>✓ Plastificirana ✓ Eloxirana</p>	<p>☞ 0,00 ☞ 0000</p>
	<p><b>IN 015</b> Mali šild za kvaku</p> <p><b>IN 016</b> Mali šild za cilindar</p>	<p>-1 par 2 kom sa zavrtnjima</p>	<p>✓ Plastificirani ✓ Eloxirani</p>	<p>☞ 1,50 ☞ 2,00</p>
	<p><b>IN 017</b> Rukohvat za vrata "Talpa"</p>	<p>-Isporučuje se sa brezonima I slepim maticama</p>	<p>L=1m; ✓ Plastificiran ✓ Eloxiran</p> <p>kom.zavrsetak .</p>	<p>☞ 40,0 ☞ 45,0</p> <p>5,00 Eura</p>

	<p><b>IN 018</b> Komplet za zaokretni prozor "CLASIC"</p> <p><b>NEMA !!!</b></p>	<p>-Ugradnja u al.sisteme sa evro žljebom</p>	<p>✓ Plastificirani ✓ Eloxirani</p>	<p>☞ 00,0 ☞ 00,0</p>
	<p><b>IN 019</b> Ugaona Spojnica za rep Profila 16 mm</p>	<p>Ugradnja u Al.sisteme sa Evro žljebom</p>	<p>Crna POLIAMID</p>	<p>0,11</p>
	<p><b>IN 020</b> Ugaona spojnica za rep profila 11 mm</p>	<p>-Ugradnja u al.sisteme sa evro žljebom</p>	<p>✓ crna POLIAMID</p>	<p>☞ 0,11</p>
	<p><b>IN 021</b> Ugaona spojnica za rep profila 5 mm</p>		<p>✓ Č . pocinkovano</p>	<p>☞ 0,05</p>
	<p><b>IN 022</b> Žabica za kit lajsnu</p> <p><b>IN 023</b> Okapnik za vodu</p>	<p>-Ugradnja u al.sisteme sa evro žljebom</p>	<p>✓ crna POLIAMID</p> <p>✓ crna POLIAMID</p>	<p>☞ 0,125</p> <p>☞ 0,10</p>

	<b>IN 024</b> Čep za dvokrilne prozore i vrata u sistemu bez termo prekida		Crna I Bela	1,00
	<b>IN 025</b> Čep za dvokrilne prozore i vrata u sistemu sa termo prekidom			1,00

INS 14	aluminijumski ugljić za krila kod visećih fasada		0,20 Eura
IN 030	pribor za cevne rukohvate celom visinom vrata		18,00 Eura
PP 1	protivpozarni dihtung secen na meru po specifikaciji	m duzni	2,18 Eura
PP 2	protivpozarni dihtung secen na meru po specifikaciji	m duzni	2,18 Eura



# PRIBOR ZA MONTAŽU CEVNIH RUKOHVATA OD CEVI Fi 50x2 i 50x2,5 CELOM VISINOM VRATA Art. IN 030

Beograd, A. Cesarca 8a  
011/3670569  
063/223754

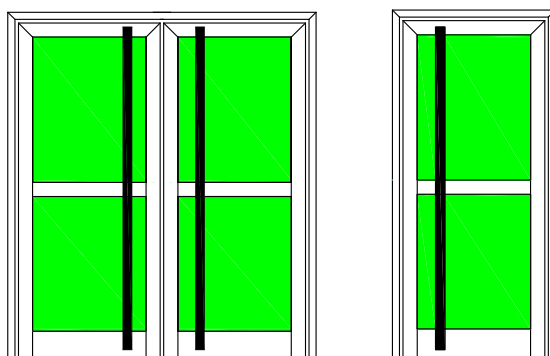

## SADRŽAJ PRIBORA :

Poz. 1	odstojnik	kom. 4
Poz. 2	polumesec	kom. 4
Poz. 3	čep	kom. 4
	brezon M8	kom. 2
	matica M8	kom. 4
	el. podložka	kom. 4
	podložka	kom. 4

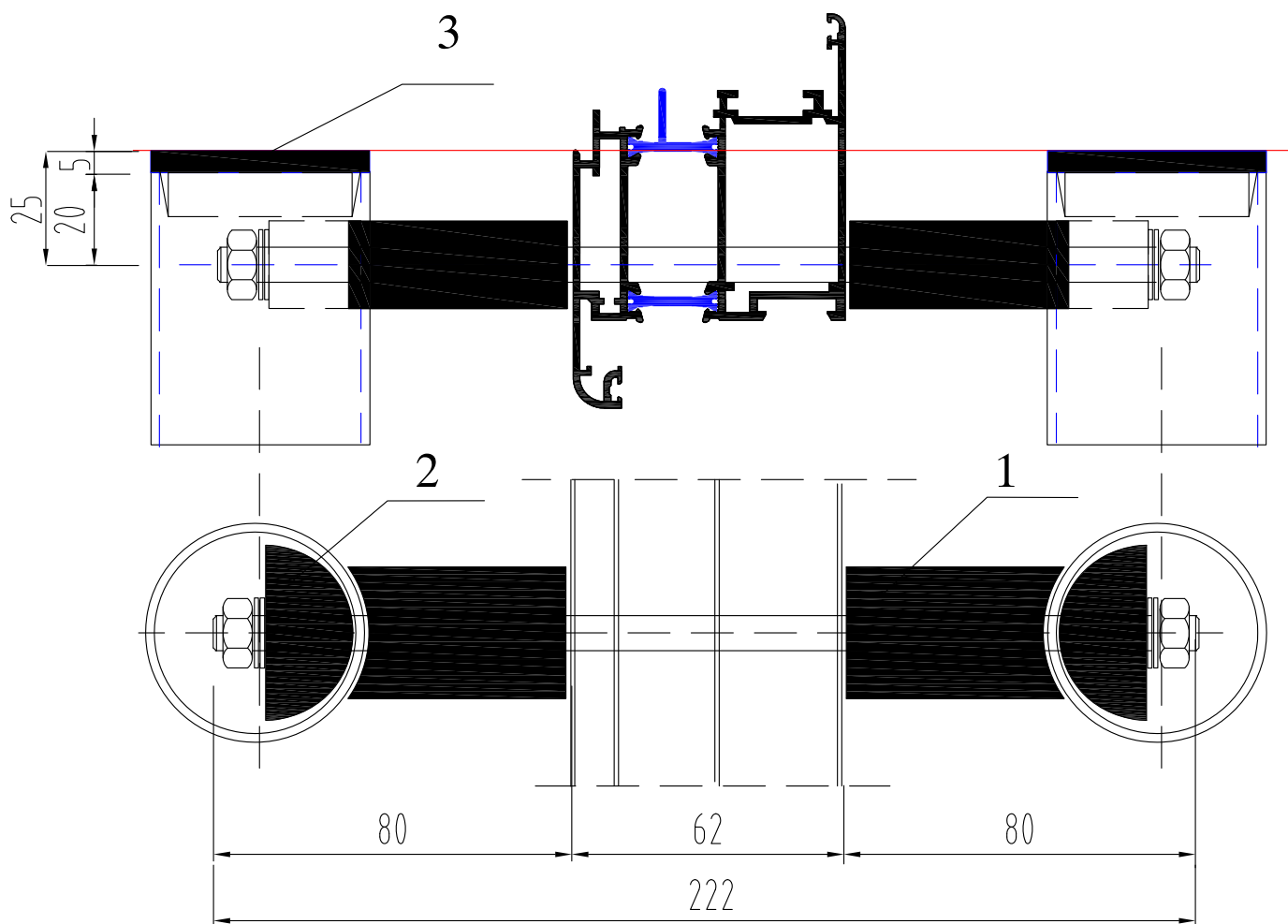

NAPOMENA : - Pribor je za al.cev Fi 50 x 2 ili Fi 50 x 2,5  
- Čepove obavezno zalepiti providnim silikonom  
- Materijal za pozicije 1,2,3 POLIAMID boja CRNA